

Linear

# MOMO-L R020

## Fixture Guide

# KKDÖ

Indoor/Outdoor | Surface | Output up to 1615lm/m (492lm/ft)



### Key applications

- ✓ Architectural detail
- ✓ Backlighting & signage
- ✓ Bathrooms
- ✓ Building facades
- ✓ Direct lighting
- ✓ Exterior
- ✓ Interior
- ✓ Mirror back lighting
- ✓ Retail display
- ✓ Wall grazing
- ✓ Wallwashing
- ✓ Window reveal
- ✓ Wet area

### Key features

- ✓ Adjustable
- ✓ Asymmetric lens
- ✓ Custom lengths
- ✓ Constant Voltage (CV)
- ✓ Diffusion: homogenous
- ✓ Direct view
- ✓ Extensive CCT range
- ✓ Glare control options
- ✓ IP44 moisture resistant
- ✓ IP67 waterproof
- ✓ Lens options

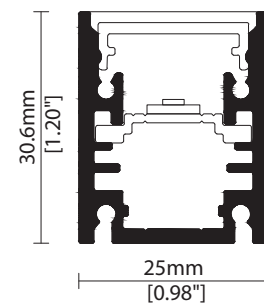

### MOUNTING METHODS

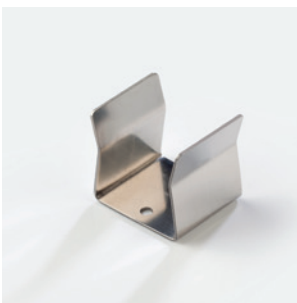

KKCP-03 Clip



KKCP-17 Lock clip



KKBK-07 Fixing plate



KKBK-21 Adjustable bracket

Linear

# MOMO-L R020

## Specification sheet

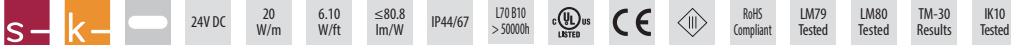

<b>Dimensions</b>	H30.6/W25/L103-2020mm* (H1.2/W0.98/L4.05-79.52in*) *KKLN-A2 = 1020mm/40.16in max
<b>PCB Cut-point</b>	41.7mm increment/2000mm max* (1.64in increment/78.74in max*) *KKLN-A2 = 1000mm/39.37in max
<b>LED Pitch</b>	6.95mm-144LED/m (0.27in - 44LED/ft)
<b>Chip</b>	<b>s-line</b> <b>k-line</b>
<b>Cover/Optics</b>	Clear (100°)/Clear + Micro louvre/Clear + KKLN-01 lens (18°)/Clear + KKLN-01 lens (18°) + Micro louvre/Clear + KKLN-03 lens (23°)/Clear + KKLN-03 lens (23°) + Micro louvre/Clear + KKLN-A2 Asymmetric lens (Beam tilt 15°, Beam angle 45°)/Diffused (95°)
<b>CCT</b>	<b>s-line:</b> 1900K/2100K/2300K/2500K/2700K/3000K/3500K/4000K/5000K <b>k-line:</b> 1900K/2100K/2300K/2500K/2700K/3000K/3500K/4000K/5000K
<b>LED binning</b>	<b>s-line:</b> 2-step MacAdam ellipse <b>k-line:</b> 3-step MacAdam ellipse
<b>CRI</b>	≥92
<b>Lifetime</b>	50,000 hours @ 25°C (50,000 hours @ 77°F)
<b>Operating temp</b>	T <sub>a</sub> = -25 to 50°C (T <sub>c</sub> max = 76.9°C) T <sub>a</sub> = -13 to 122°F (T <sub>c</sub> max = 170.4°F)
<b>IP Rating</b>	IP44/67
<b>Finish</b>	Silver anodised
<b>Mounting</b>	Surface mounting via clips or brackets
<b>Power feed</b>	Sheathed hardwire tails or male/female connectors
<b>Control</b>	0-10V/1-10V/DMX/DALI



### LED Grading Key

#### Exclusive Grade

<b>s-line*</b>	*KKDC tuned CCT range
2-step CCT range	

#### Base Grade

<b>k-line</b>	3-step commercial range Energy Star CCTs
---------------	---

<b>Power consumption</b>	<b>Supply voltage</b>	<b>Supply current</b>
20W/m (6.10W/ft)	24V DC	0.83A/m (0.25A/ft)

### Performance Data (3000K)

<b>k-line</b>	R1	R2	R3	R4	R5	R6	R7	R8	R9	R10	R11	R12	R13	R14
	93	97	97	90	91	95	91	82	62	92	90	75	94	99

	Clear	Clear + Micro Louvre	Clear + KKLN-01 (18°)	Clear + KKLN-01 (18°) + Micro Louvre	Clear + KKLN-03 (23°)	Clear + KKLN-03 (23°) + Micro Louvre	Clear + KKLN-A2 Asymmetric lens	Diffused Cover	CRI	R9	Rf	Rg
<b>s-line</b>	1615lm/m (492lm/ft) 80.8lm/W	470lm/m (143lm/ft) 23.5lm/w	893lm/m (272lm/ft) 44.6lm/W	443lm/m (135lm/ft) 22.2lm/W	901lm/m (275lm/ft) 45.1lm/W	507lm/m (154lm/ft) 25.3lm/W	1615lm/m (492lm/ft) 80.8lm/W	719lm/m (219lm/ft) 35.9lm/W	93	65	-	-
<b>k-line</b>	1524lm/m (465lm/ft) 76.2lm/W	444lm/m (135lm/ft) 22.2lm/w	842lm/m (257lm/ft) 42.1lm/W	418lm/m (127lm/ft) 20.9lm/W	850lm/m (259lm/ft) 42.5lm/W	478lm/m (146lm/ft) 23.9lm/W	1524lm/m (465lm/ft) 76.2lm/W	678lm/m (207lm/ft) 33.9lm/W	92	64	-	-

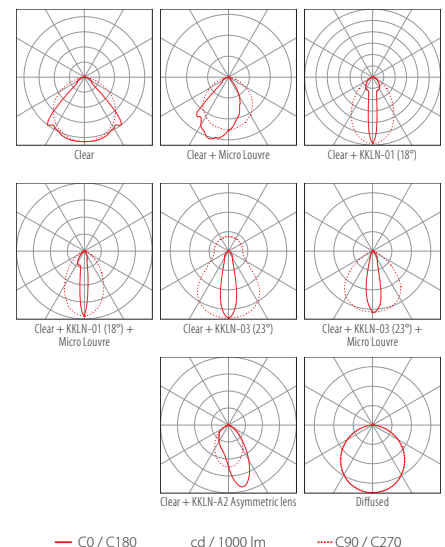
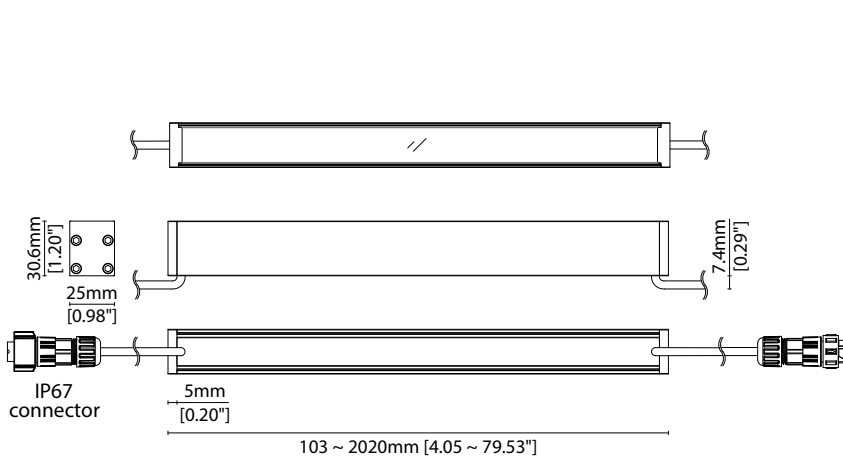

Data derived from independent UKAS/IESNA LM-79-08 accredited testing of production samples.

### FIXTURE

Model	Finish	Cover/Lens <sup>1</sup>	Grade <sup>2</sup>	LED	Colour (CCT)	Length Availability <sup>3</sup>	IP	Cable Length	Power Feed <sup>4</sup>	Input																
MOMO-L	MO Silver Anodised	SA	Clear	B	R020	R020	1900K	19	m	103.3-2020mm 41.7mm increments	IP44	44	300mm/ 11.81"	0300	Single ø4.3mm sheath tail	S00A	DC 24V	g								
			Clear + Micro Louvre	K		2100K	21	i							4.05-79.52in 1.64in increments	IP67 <sup>5</sup>			67	Double ø4.3mm sheath tail	D00A					
			Clear + 18° (KKLN-01)	P		2300K	23													(Specify length code OR total run length)	Single ø4.3mm sheath IP67 connector	S67A				
			Clear + 18° (KKLN-01) + Micro Louvre	U		2500K	25														Double ø4.3mm sheath IP67 connector	D67A				
			Clear + 23° (KKLN-03)	A		2700K	27														5000K	50				
			Clear + 23° (KKLN-03) + Micro Louvre	AK		3000K	30																			
			Clear + KKLN-A2	BA2		3500K	35																			
			Diffused	C		4000K	40																			
						5000K	50																			

<sup>1</sup> Refer to **Cover/Lens Options** on **Options** pages

<sup>2</sup> Refer to **LED Grading Key** on **Specification sheet** page

<sup>3</sup> Refer to **Length Availability List** or enter total run length instead of length code

<sup>4</sup> Refer to **Power Feed Options** on **Options** pages

<sup>5</sup> Due to the clear, flush potted polyurethane top layer on IP67 MOMO-L a colour shift of +/- 20K should be expected

### Code Example:

MO	-	SA	-	C	-	s	-	R020	-	35	-	m	520	-	67	-	0300	-	D67A	-	g
MOMO-L		Silver Anodised		Diffused				R020		3500K		520mm		IP67		300mm/11.81"		Double ø4.3mm sheath IP67 connector		DC 24V	

### ACCESSORIES

#### Mounting Accessories

KKCP-03	Clip (1no.)
KKCP-53	Clip (500no.)
KKCP-17	Lock Clip
KKBK-07	Fixing plate
KKBK-21	Adjustable bracket

\* Refer to **Mounting accessories** on **Accessories** pages

#### Connection Accessories

CN67-2P-0300	IP67 2 PIN male & female 300mm/11.81" pair
CN67-2P-1000	IP67 2 PIN male & female 1000mm/39.37" pair
CN67-2P-3000	IP67 2 PIN male & female 3000mm/118.11" pair

\* Refer to **Power feed** on **Accessories** pages

#### Exterior Junction Boxes

KKJB-07	IP67 Slim J-Box
KKJB-07R	Potting Resin for IP67 Slim J-Box

\* Refer to **Exterior Junction Boxes** on **Accessories** pages

#### PSU/Driver

0-10V/1-10V/DALI/DMX

\* Refer to **Driver/PSU Options** page for details or provide requirement and KKDC to offer the suitable option

### LED ENGINE VARIANTS (LED STRIP TYPE)

Colour	LED	Lumen/m	Lumen/ft	W/m	W/ft	Spec Doc	Length	Increment
Single CCT	R007	557	170	7	2.13	MOMO-L R007	103.3-2020mm (4.05-79.52in)	41.7mm (1.64in)
	R014	1140	374	14	4.27	MOMO-L R014	103.3-2020mm (4.05-79.52in)	41.7mm (1.64in)
	<b>R020</b>	<b>1615</b>	<b>492</b>	<b>20</b>	<b>6.10</b>	<b>MOMO-L R020</b>	<b>103.3-2020mm (4.05-79.52in)</b>	<b>41.7mm (1.64in)</b>
Warm Dim/Dynamic White	R030	2286	697	30	9.14	MOMO-L R030	103.3-2020mm (4.05-79.52in)	41.7mm (1.64in)
	A040	3640	1109	40	12.19	MOMO-L A040	97-1520mm (3.82-59.84in)	38.46mm (1.51in)
RGB	R207	1289	393	16	4.88	MOMO-L R207	103.3-2020mm (4.05-79.52in)	83.3mm (3.28in)
		501	Red 125 Green 266 Blue 42 RGB 383	Red 38 Green 81 Blue 13 RGB 117	15.6	4.75	MOMO-L RGB	103.3-2020mm (4.05-79.52in)
RGBW	R201	973	297	20	6.1	MOMO-L RGBW	155-2030mm (6.10-79.92in)	62.5mm (2.46in)

\* Performance data: A/s-line, clear cover, 3000K

# MOMO-L R020

## Length Availability List



Length Code		Fixture Length <sup>1</sup>		LED Strip <sup>2</sup>		End Cap Dimension <sup>3</sup>		Wattage (W)	Output (lm)
Metric	Imperial(US)	Metric	Imperial(US)	Metric	Imperial(US)	Metric	Imperial(US)		3000K (Test Data)
m0103	i0004	103mm	4.07in	83mm	3.28in	10mm	0.39in	1.67	127
m0145	i0006	145mm	5.71in	125mm	4.92in	10mm	0.39in	2.50	191
m0187	i0007	187mm	7.35in	167mm	6.56in	10mm	0.39in	3.33	254
m0228	i0009	228mm	8.99in	208mm	8.20in	10mm	0.39in	4.17	318
m0270	i0011	270mm	10.63in	250mm	9.84in	10mm	0.39in	5.00	381
m0312	i0012	312mm	12.27in	292mm	11.48in	10mm	0.39in	5.83	444
m0353	i0014	353mm	13.91in	333mm	13.12in	10mm	0.39in	6.67	508
m0395	i0016	395mm	15.55in	375mm	14.76in	10mm	0.39in	7.50	572
m0437	i0017	437mm	17.19in	417mm	16.40in	10mm	0.39in	8.33	635
m0478	i0019	478mm	18.83in	458mm	18.04in	10mm	0.39in	9.17	699
m0520	i0020	520mm	20.47in	500mm	19.69in	10mm	0.39in	10.00	762
m0562	i0022	562mm	22.11in	542mm	21.33in	10mm	0.39in	10.83	825
m0603	i0024	603mm	23.75in	583mm	22.97in	10mm	0.39in	11.67	889
m0645	i0025	645mm	25.39in	625mm	24.61in	10mm	0.39in	12.50	953
m0687	i0027	687mm	27.03in	667mm	26.25in	10mm	0.39in	13.33	1016
m0728	i0029	728mm	28.67in	708mm	27.89in	10mm	0.39in	14.17	1080
m0770	i0030	770mm	30.31in	750mm	29.53in	10mm	0.39in	15.00	1143
m0812	i0032	812mm	31.96in	792mm	31.17in	10mm	0.39in	15.83	1206
m0853	i0034	853mm	33.60in	833mm	32.81in	10mm	0.39in	16.67	1270
m0895	i0035	895mm	35.24in	875mm	34.45in	10mm	0.39in	17.50	1334
m0937	i0037	937mm	36.88in	917mm	36.09in	10mm	0.39in	18.33	1397
m0978	i0039	978mm	38.52in	958mm	37.73in	10mm	0.39in	19.17	1461
m1020	i0040	1020mm	40.16in	1000mm	39.37in	10mm	0.39in	20.00	1524
m1062	i0042	1062mm	41.80in	1042mm	41.01in	10mm	0.39in	20.83	1587
m1103	i0043	1103mm	43.44in	1083mm	42.65in	10mm	0.39in	21.67	1651
m1145	i0045	1145mm	45.08in	1125mm	44.29in	10mm	0.39in	22.50	1715
m1187	i0047	1187mm	46.72in	1167mm	45.93in	10mm	0.39in	23.33	1778
m1228	i0048	1228mm	48.36in	1208mm	47.57in	10mm	0.39in	24.17	1842
m1270	i0050	1270mm	50.00in	1250mm	49.21in	10mm	0.39in	25.00	1905
m1312	i0052	1312mm	51.64in	1292mm	50.85in	10mm	0.39in	25.83	1968
m1353	i0053	1353mm	53.28in	1333mm	52.49in	10mm	0.39in	26.67	2032
m1395	i0055	1395mm	54.92in	1375mm	54.13in	10mm	0.39in	27.50	2096
m1437	i0057	1437mm	56.56in	1417mm	55.77in	10mm	0.39in	28.33	2159
m1478	i0058	1478mm	58.20in	1458mm	57.41in	10mm	0.39in	29.17	2223
m1520	i0060	1520mm	59.84in	1500mm	59.06in	10mm	0.39in	30.00	2286
m1562	i0061	1562mm	61.48in	1542mm	60.70in	10mm	0.39in	30.83	2349
m1603	i0063	1603mm	63.12in	1583mm	62.34in	10mm	0.39in	31.67	2413
m1645	i0065	1645mm	64.76in	1625mm	63.98in	10mm	0.39in	32.50	2477
m1687	i0066	1687mm	66.40in	1667mm	65.62in	10mm	0.39in	33.33	2540
m1728	i0068	1728mm	68.04in	1708mm	67.26in	10mm	0.39in	34.17	2604
m1770	i0070	1770mm	69.69in	1750mm	68.90in	10mm	0.39in	35.00	2667
m1812	i0071	1812mm	71.33in	1792mm	70.54in	10mm	0.39in	35.83	2730
m1853	i0073	1853mm	72.97in	1833mm	72.18in	10mm	0.39in	36.67	2794

# MOMO-L R020

## Length Availability List



Length Code		Fixture Length <sup>1</sup>		LED Strip <sup>2</sup>		End Cap Dimension <sup>3</sup>		Wattage (W)	Output (lm)
Metric	Imperial(US)	Metric	Imperial(US)	Metric	Imperial(US)	Metric	Imperial(US)		3000K (Test Data)
m1895	i0075	1895mm	74.61in	1875mm	73.82in	10mm	0.39in	37.50	2858
m1937	i0076	1937mm	76.25in	1917mm	75.46in	10mm	0.39in	38.33	2921
m1978	i0078	1978mm	77.89in	1958mm	77.10in	10mm	0.39in	39.17	2985
m2020	i0080	2020mm	79.53in	2000mm	78.74in	10mm	0.39in	40.00	3048

<sup>1</sup> Actual total overall length of light fixture (LED strip + end caps + void/wire hole)

<sup>2</sup> Actual length of PCB strip

<sup>3</sup> Actual length of 2x end caps

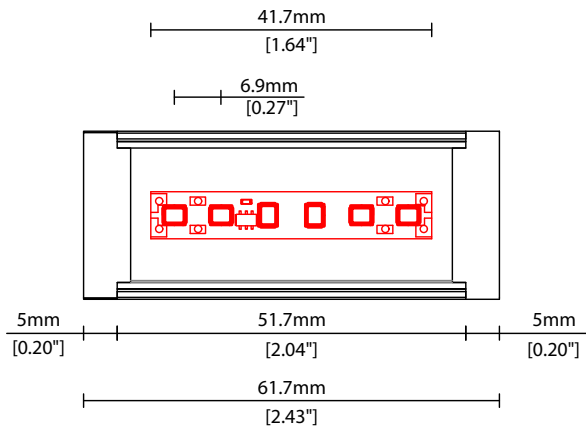

### COVER/LENS OPTIONS

\* Options are an integral part of the fixture ordering codes. Please refer to **Code Table** pages.

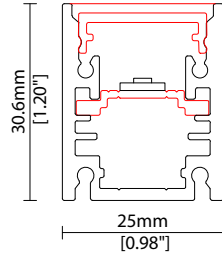
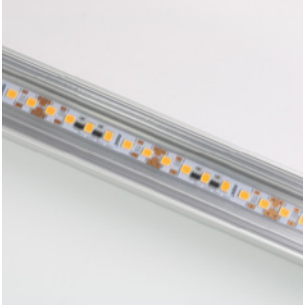

**B** Clear Cover  
W25.0/H30.6mm (W0.98/H1.20")

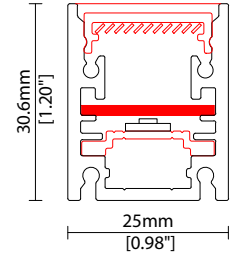
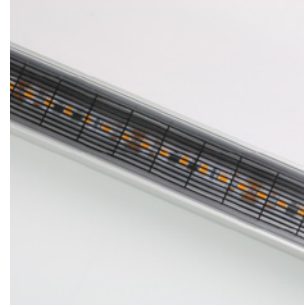

**K** Clear Cover + Micro Louvre  
(diffused internal cover)  
W25.0/H30.6mm (W0.98/H1.20")

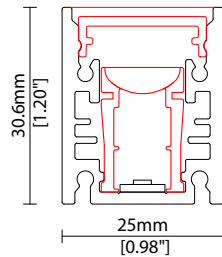
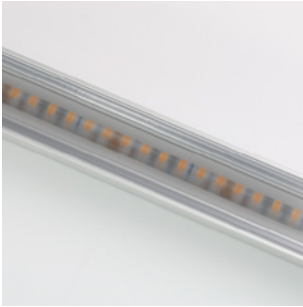

**P** Clear Cover + 18° (KKLN-01)  
W25.0/H30.6mm (W0.98/H1.20")

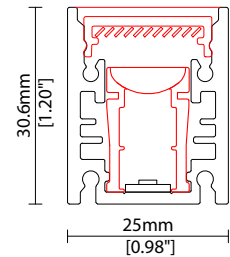

**U** Clear Cover + 18°  
(KKLN-01) + Micro louvre  
W25.0/H30.6mm (W0.98/H1.20")

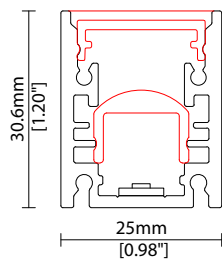

**A** Clear Cover + 23°  
(KKLN-03) lens  
W25.0/H30.6mm (W0.98/H1.20")

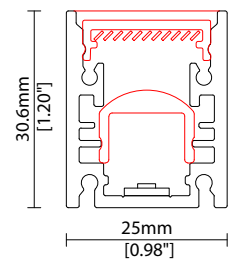

**AK** Clear Cover + 23° (KKLN-03)  
lens + Micro Louvre  
W25.0/H30.6mm (W0.98/H1.20")

Linear

# MOMO-L R020

## Options

# KKDC

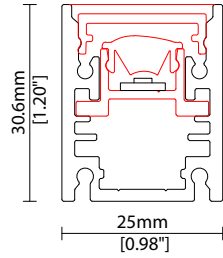

**BA2** Asymmetric lens (KKLN-A2)  
W25.0/H30.6mm (W0.98/H1.20")

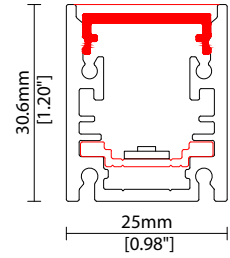

**C** Diffused Cover  
W25.0/H30.6mm (W0.98/H1.20")

### POWER FEED OPTIONS

0300 S00A 300mm (11.81") Single Ø4.3mm sheath tail

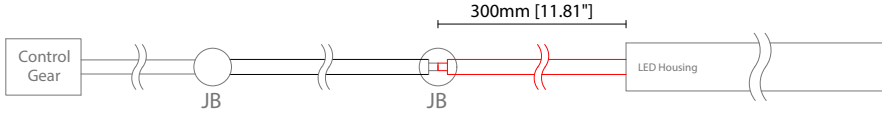

0300 D00A 300mm (11.81") Double Ø4.3mm sheath tail

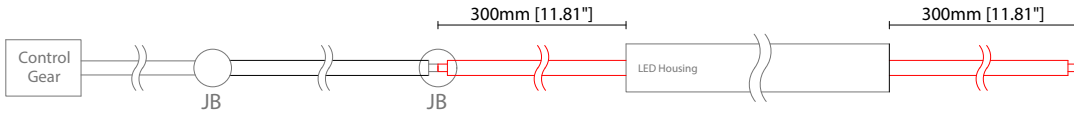

0300 S67A 300mm (11.81") Single ø4.3mm sheath IP67 connector

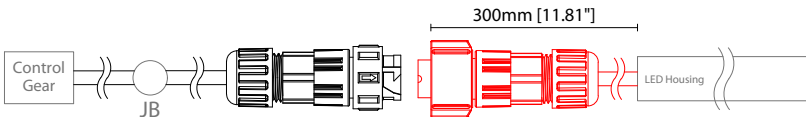

0300 D67A 300mm (11.81") Double ø4.3mm sheath IP67 connector

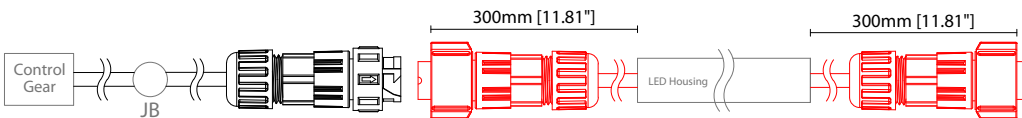

### IP67 2 Pin Connector

Female connector  
2 PIN (IP67)

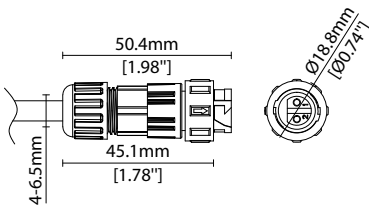

Male connector  
2 PIN (IP67)

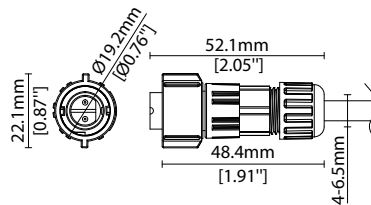

### Key

- Control Gear Power supply, sub-controllers & control systems
- JB Junction box / cable connection



### MOUNTING ACCESSORIES

Note: Accessories are to be ordered separately with corresponding code shown below.



**KKCP-03** (1no.)  
**KKCP-53** (500no.)  
 Clip (allow 3 per metre/40in)  
 S/Steel finish  
 L25/W33.1/H33.5mm  
 (L0.98/W1.3/H1.32")

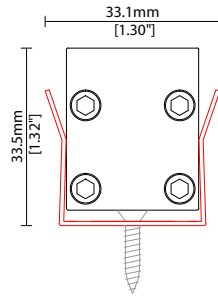

**KKCP-17**  
 Lock clip (allow 2 per metre/40in)  
 S/Steel finish  
 L25/W26.1/H45mm  
 (L0.98/W1.03/H1.77")

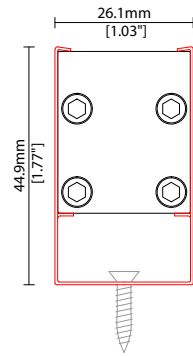

**KKBK-07**  
 Fixing plate (allow 2 per metre/40in)  
 Anodised aluminium finish  
 L50/W25/H38mm  
 (L1.97/W0.98/H1.5")  
 Pre-assembled in factory

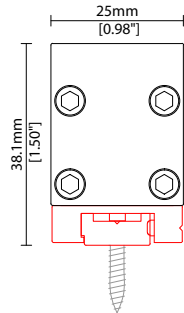

**KKBK-21**  
 Adjustable bracket (allow 2 per metre/40in)  
 Anodised aluminium finish  
 L34/W25/H41.9mm  
 (L1.34/W0.98/H1.65")  
 Pre-assembled in factory

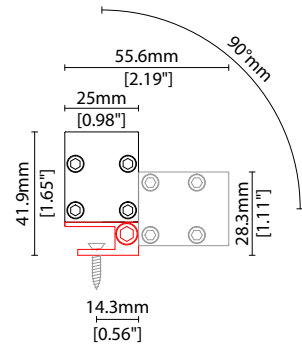

### POWER FEED

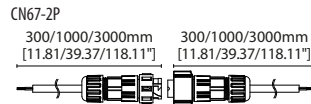

**CN67-2P-0300** 300mm (11.81in) pair  
**CN67-2P-1000** 1000mm (39.37in) pair  
**CN67-2P-3000** 3000mm (118.11in) pair  
 IP67  
 2 PIN male + female connector set

### EXTERIOR JUNCTION BOXES



**KKJB-07**

IP67 Slim J-Box  
(including type A,B,C,D bushings)



**KKJB-07R**

Potting resin for IP67 Slim J-Box

### KKDC CONTROL



**KKDM-06** 1-10V

visDIM dimmable sub-controller  
(4 x 8A max @ 12-36V)

IP20  
Plastic housing  
L170/W59/H29mm  
(L6.69/W2.32/H1.14in)



**KKSC-05** DMX

visDIM dimmable sub-controller  
(4 x 5A max @ 12-36V)

IP20  
Plastic housing  
L170/W53.4/H28mm  
(L6.69/W2.10/H1.10in)



**KKDL-02** DALI

visDIM dimmable sub-controller  
(4 x 8A max @ 12-36V)

IP20  
Plastic housing  
L170/W59/H29mm  
(L6.69/W2.32/H1.14in)



**KKDL-03** DALI

visDIM dimmable sub-controller  
(4 x 5A max @ 12-36V)

IP20  
Plastic housing  
L166/W53.4/H23mm  
(L6.54/W2.10/H0.91in)

### AVAILABLE PSU OPTIONS

Control Mode	PSU (Order Code)	Input Voltage AC	Output Voltage DC	Rated Output Current	Rated Power	Dim %	IP Rating
Switched	CEN-60-24	90-295V	24V	2.5A	60W	-	IP67
	HLG-60H-24	90-305V	24V	2.5A	60W	-	IP67
	HLG-100H-24	90-305V	24V	4.0A	100W	-	IP67
	HLG-150H-24	90-305V	24V	6.3A	150W	-	IP67
	HLG-240H-24	90-305V	24V	10A	240W	-	IP67
0-10V (1-10V)	PWM-40-24	90-305V	24V	1.67A	40W	100-0.15 (100-10)	IP67
	PWM-60-24	90-305V	24V	2.5A	60W	100-0.15 (100-10)	IP67
	PWM-90-24	90-305V	24V	3.67A	90W	100-0.15 (100-10)	IP67
	PWM-120-24	90-305V	24V	5.0A	120W	100-0.15 (100-10)	IP67
DALI	LIN100A1	120-277V	24V	1A per channel	100W	100-0.1	IP66/IP40
DMX RGB	LIN100A1	120-277V	24V	1.33A per channel	100W	100-0.1	IP66/IP40
DMX RGBW	LIN100A1	120-277A	24V	1A per channel	100W	100-0.1	IP66/IP40

### Flicker Free Options - Combination of PSU+ sub-controller

Control Mode	PSU (Order Code)	Sub-controller (Order Code)	Input Voltage AC	Output Voltage DC	Rated Output Current	Rated Power	Dim %	IP Rating PSU/ Sub-controller
0-10V or 1-10V	CEN-60-24	KKDM-06	90-295V	24V	2.5A	60W	100-0.9	IP67/IP20
	HLG-60H-24	KKDM-06	90-295V	24V	2.5A	60W	100-0.9	IP67/IP20
	HLG-100H-24	KKDM-06	90-295V	24V	4.0A	100W	100-0.9	IP67/IP20
	HLG-150H-24	KKDM-06	90-295V	24V	6.3A	150W	100-0.9	IP67/IP20
	HLG-240H-24	KKDM-06	90-295V	24V	10.0A	240W	100-0.9	IP67/IP20
DALI	CEN-60-24	KKDL-02/03	90-295V	24V	2.5A	60W	100-0.1	IP67/IP20
	HLG-60H-24	KKDL-02/03	90-305V	24V	2.5A	60W	100-0.1	IP67/IP20
	HLG-100H-24	KKDL-02/03	90-305V	24V	4.0A	100W	100-0.1	IP67/IP20
	HLG-150H-24	KKDL-02/03	90-305V	24V	6.3A	150W	100-0.1	IP67/IP20
	HLG-240H-24	KKDL-02/03	90-305V	24V	10.0A	240W	100-0.1	IP67/IP20
DMX RGB	CEN-60-24	KKSC-05	90-295V	24V	2.5A	60W	100-0.9	IP67/IP20
	HLG-60H-24	KKSC-05	90-305V	24V	2.5A	60W	100-0.9	IP67/IP20
	HLG-100H-24	KKSC-05	90-305V	24V	4A	100W	100-0.9	IP67/IP20
	HLG-150H-24	KKSC-05	90-305V	24V	6.3A	150W	100-0.9	IP67/IP20
	HLG-240H-24	KKSC-05	90-305V	24V	10.0A	240W	100-0.9	IP67/IP20

<sup>1</sup> The items shown above cover the most frequently used specification but does not exhaust the possible options

<sup>2</sup> PSU and/or driver can be chosen from the table, or KKDC may recommend the best option upon receipt of the controls requirement and installation environment

<sup>3</sup> Electrical shop drawing will include detailed information of PSU and relevant control drivers

<sup>4</sup> Cut sheets are available on the controls section of [www.kkdc.lighting](http://www.kkdc.lighting) or upon request